

User Guide

AutoSealer

1002

Operation & Service



121 Point West Boulevard
St. Charles, MO 63301
1-800-922-9142
fax:1-636-925-0041
TSR@RxSystems.com
RxSystems.com

Table of Contents

1. Introduction	page 1
2. Specifications and Features	page 2
2.1 Specifications	page 2
2.2 Features	page 2
3. Identification of Controls	page 3
3.1 Power Inlet Module	page 3
3.2 Cooling Fan And Air Intakes	page 3
3.3 Select Dial	page 4
3.4 Control Status Display	page 4
3.5 Red Stop / Emergency Button	page 4
3.6 Cycle / Start Buttons	page 4
4. Initial Setup	page 5
4.1 Remove from Packaging	page 5
4.2 Place in New Home	page 5
4.3 Plug In	page 5
5. Daily Power Up Routine	page 6
5.1 Turn On	page 6
5.2 Press Select Dial	page 6
5.3 Allow to Heat Up	page 6
5.4 Ready to Use	page 6
6. Daily Operation	page 7
6.1 Prepare Pill Cards	page 7
6.2 Insert Pill Cards	page 7
6.3 Press Cycle Buttons	page 7
6.4 Allow Seal Time to Complete	page 7
6.5 Remove Pill Cards	page 7
7. Understanding the Menu (User Controls)	page 8
7.1 Heat O° and On	page 8
7.2 Reset Batch Count	page 8
7.3 Return to Main Operating Screen	page 8
8. Understanding the Menu (Admin Controls)	page 9
8.1 Set Temperature	page 9
8.2 Set Seal Time	page 9
8.3 System Maintenance	page 9
8.4 Return to Main Operating Screen	page 9
9. Parts List	page 10
10. Troubleshooting	page 11
11. Schematic	page 12
12. Accessories	page 13,14
13. Warranty	page 15
14. Maintenance Log	page 16

1. Introduction

Rx Systems, Inc is very pleased you decided to join the growing number of AutoSealer owners.

This User Guide will make you familiar with the features, operating principles, procedures, necessary maintenance and troubleshooting of the Rx Systems AutoSealer.

With proper care and maintenance you can expect years of trouble free service.

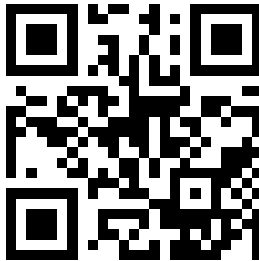

To order online please visit: store.rxsystems.com

2. Specifications and Features

2.1 Specifications

- Length: 14.5"
- Width: 17"
- Height: 9.75"
- Weight: 47 lbs
- Electrical: 115 VAC, 12 Amp, 1380 Watts, 60 Hz

2.2 Features

- Controlled Temperature, Time and Pressure for a worry-free Seal.
- Adjustable Sealing Time and Temperature
- Automatic Pressure Adjustment: consistent seal for most card sizes and blister depths.
- Safe two hand operation.
- Emergency Shuto°.
- All electric, no compressor required.
- Energy efficient.
- Air cooled outer shell, insulated heat plate.
- Minimal moving parts provide reliable operation.
- Easy access and quick change parts for routine maintenance, when required.
- Presents Live Batch / Cycle Count.
- Flattop design provides additional work space.
- Unique Paddles reduce moisture during seal.

3. Identification of Controls

3.1 Power Inlet Module

- All in One; Power Plug, Power Switch and Breaker
- **Use Approved Power Cord Only (provided).**

3.2 Cooling Fan & Air Intake Vent

- Cool air from Air Intake Vent flows through the AutoSealer and exhausts from Cooling Fan; keeping the internal components and cover cool.
- **Do not impede or block the Cooling Fan or Air Intake Vent.**

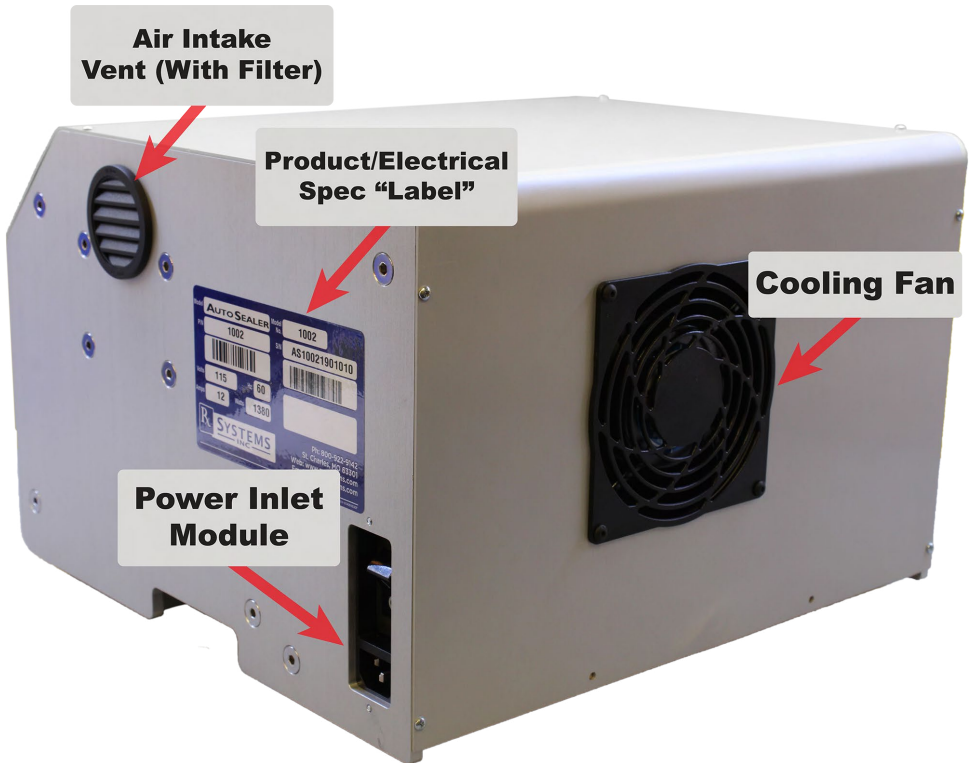

3. Identification of Controls (continued)

3.3 Select Dial

Used to Interact with AutoSealer Menu.

When instructed, do one of the following;

- Press & Release
- Press & Hold
- Twist Left or Twist Right

3.4 Control Status Display

• Shows Live; Status, Operation, Temperature, Seal Time and Batch Count.

3.5 Red Stop / Emergency Button

• Stops or Reverses Cycle

3.6 Cycle/ Start Buttons

• Start the Cycle, by pressing Both buttons at the same time.

Two Handed Operation for Safety.



4. Initial Setup

4.1 Remove the AutoSealer from it's packaging.

- If ordered, a Sealing Paddle will be (packaged) on top.
- For future shipping purposes, save all of the packaging materials.
- This approved packaging is required for shipping.
- Remove the Cardboard Insert from inside the mouth of the AutoSealer before operating machine.

4.2 Place AutoSealer in it's new home.

- Leave a sufficient amount of space around the AutoSealer area.
- Do not impede or block the Cooling Fan or Air Intake Vents.

4.2 Plug the AutoSealer into a standard grounded outlet.

- Use Approved Power Cord Only (provided).
 - It is recommended to use a dedicated 15 amp outlet.



5. Daily Power Up Routine

5.1 Turn the Power Switch ON.

```
Press SELECT button  
to turn heat ON and  
move plate to  
upper position
```

5.2 Press & Release the Select Dial to Turn Heat ON & Raise Heat Plate.

5.3 Allow the AutoSealer to heat up 10 to 15 minutes. AutoSealer will not operate until it is up to set temperature.

```
Wait - Heating Up  
Seal Time      = 3.0  
Temperature    = 76  
Batch Count    = 0
```

When the AutoSealer is ready the screen will show 

```
* Ready to Cycle *  
Seal Time      = 3.0  
Temperature    = 315  
Batch Count    = 0
```

5.4 Your AutoSealer is now ready for operation.

Note:

Your New AutoSealer is preprogrammed to seal all Rx Systems heat seal pill cards. This User Guide will cover settings & adjustments on a separate page.

6. Daily Operation

The AutoSealer will automatically seal pill cards at a constant temperature and pressure over a set time - you only need to push both cycle buttons to start the sealing cycle. However, before you do there are some preparations you need to make.

6.1 Prepare pill cards in sealing paddle and close the pill card.

6.2 Insert sealing paddle into AutoSealer.

6.3 Press both Cycle Buttons at the same time.

The AutoSealer will now apply heat & pressure to the pill cards. This two handed action is for safety

During this operation the screen will show →

```
Cycle in Progress
Seal Time      =  1.5
Temperature    =  315
Batch Count    =  41
```

6.4 The heat plate will return when it is complete. The default seal time is 3 seconds.

When complete the screen will return to →

```
Ready to Cycle *
Seal Time      =  3.0
Temperature    =  315
Batch Count    =  42
```

6.5 Remove paddle as the pill cards are now sealed.

7. Understanding the Menu (User Controls)

7.1 Heat O° & On

```
Heater = ON
Turn ---> for ON
Turn <--- for OFF
then press select
```

Press and Hold the Select Dial for 1 Second

```
Heater = OFF
Turn --> for ON
Turn <-- for OFF
then press select
```

To turn the Heat OFF
Twist Select Dial Left

(this will allow you to cycle the AutoSealer immediately)

```
Heater = ON
Turn ---> for ON
Turn <--- for OFF
then press select
```

To turn the Heat ON
Twist Select Dial Right

7.2 Batch Count

```
Count Reset = YES
Turn ---> for YES
Turn <--- for NO
then press select
```

Press and Release the Select Dial
To NOT Reset the Batch Count
Twist Dial Left

```
Count Reset = NO
Turn ---> for YES
Turn <--- for NO
then press select
```

To Reset the Batch Count
Twist Select Dial Right

(this will immediately take you the main operating screen)

7.3 Return to Main Operating Screen

```
Ready to Cycle *
Seal Time = 3.0
Temperature = 315
Batch Count = 42
```

7.3 Press and Release the Select Dial to return to the main operating screen

8. Understanding the Menu (Admin Controls)

8.1 Temperature adjustment

```
*** Auto Sealer ***
Select Temp Setpoint
Range = 250-330 DegF
Temp Setpoint = 315
```

Press and Hold the Stop Button AND the Select Dial for 1 Second

```
*** Auto Sealer ***
Select Temp Setpoint
Range = 250-330 DegF
Temp Setpoint = 300
```

To Decrease the Temperature Set Point Twist Select Dial Left

Default is 315°F

```
*** Auto Sealer ***
Select Temp Setpoint
Range = 250-330 DegF
Temp Setpoint = 320
```

To Increase the Temperature Set Point Twist Select Dial Right

```
*** Auto Sealer ***
Select Seal Time
Range = 2.0-9.0 Secs
Seal Time = 3.0
```

8.2 Seal Time Adjustment

Press and Release the Select Dial

```
*** Auto Sealer ***
Select Seal Time
Range = 2.0-9.0 Secs
Seal Time = 2.5
```

To Decrease the Seal Time Twist Select Dial Left

Default is 3.0 Seconds

```
*** Auto Sealer ***
Select Seal Time
Range = 2.0-9.0 Secs
Seal Time = 4.2
```

To Increase the Seal Time Twist Select Dial Right

8.3 System Maintenance

Press and Release the Select Dial to show the System Maintenance Screen

```
*System Maintenance*
Life Count = 000003
Inputs = 111011
Internal T = 77DEGF
```

This screen is for Troubleshooting Purposes

<---Shows TotalTimes Machine has been Cycled (ie: Odometer)

<---Shows Inputs / Controls as Binary:1 = ON,0 = Off

<---Shows Internal Temperature of the MainControl Board

```
Ready to Cycle *
Seal Time = 3.0
Temperature = 315
Batch Count = 42
```

8.4 Press and Release the Select Dial to return to the main operating screen

9. AS1002 Parts

Part Number	Description
AS100201	Control Panel Complete Assembly
AS100202	RH Button
AS100203	LH Button
AS100204	Stop Button Only
AS100205	Select Switch and Knob
AS100205D	Select Knob
AS100206	Display
AS100207	Power Switch
AS100207A	Power Switch Adapters
AS100209	SS Cover with Screws
AS100210	Intake Vents
AS100211	Feet with Screws
AS100212	Belt Only
AS100213	Circuit Board
AS100214	Servo Power Supply
AS100215	Thermocouple
AS100216	Servo Motor with Cables
AS100217	Pulley Complete Assembly
AS100218	Spindle Complete Assembly
AS100219	Heat Plate Complete Assembly
AS100220	Box with Inserts
4503A	Fan
4534	Solid State Relay
4552	Power Inlet

10. Trouble Shooting

Problem	Solution
Blank Screen, No Power	<ul style="list-style-type: none"> -- Check Power Switch (in ON Position) -- Check Power Cord (securely plugged in to Wall and AutoSealer) -- Check Main (House Breaker) -- Check AutoSealer Fuses (if applicable)
No Motion, Heat Plate will not go Down	<ul style="list-style-type: none"> -- Check Temperature (AutoSealer will not Cycle if not up to Temperature) -- Insure Both Cycle Buttons are being activated at the same time -- Check Inputs on "System Maintenance" Screen (Found in Admin Controls) -- Faulty Timing Belt - See Parts List - Contact Rx Systems -- Bound Heat Plate - Contact Rx Systems - Remove Power Cord and Cover, Carefully Rotate Pulley by hand to insure free movement
Stuck Paddle, No Motion, Heat Plate will not return (go Up)	<ul style="list-style-type: none"> -- Press Stop Button -- Check Inputs on "System Maintenance" Screen (Found in Admin Controls) -- Broken Timing Belt - See Parts List - Contact Rx Systems - Remove Power Cord and Cover, Carefully Rotate Pulley by hand to insure free movement -- Bound Heat Plate - Contact Rx Systems - Remove Power Cord and Cover, Carefully Rotate Pulley by hand to insure free movement
No Heat, will not Heat Up	<ul style="list-style-type: none"> -- Heat Turned 0° - See Heater Controls (Found in User Controls) -- Faulty Heat Element - See Parts List - Contact Rx Systems
Erratic Temperature readings	<ul style="list-style-type: none"> -- Faulty Thermocouple - See Parts List - Contact Rx Systems
Cooling Fan will not come on	<ul style="list-style-type: none"> -- Heat Plate not up to Temperature - Cooling Fan will only come on after the heat plate is up to temperature for 10 minutes. -- Faulty Cooling Fan - See Parts List - Contact Rx Systems
Heat Plate Dirty	<ul style="list-style-type: none"> -- Remove bottom support plate (3 allen screws along both sides of machine) and remove debris -- Contact Rx Systems

Before servicing; make sure to disconnect power cord and Heat Plate is cool

If you any questions or concerns, please contact Rx Systems.
 1-800-922-9142 - TSR@RxSystems.com - (Please have the AutoSealer Serial Number handy)
 We will be happy to assist you.

11. Schematic

AUTOSEALER 1002

CUSTOMER SUPPLIED POWER
15AMPS @ 110VAC 1 PHASE

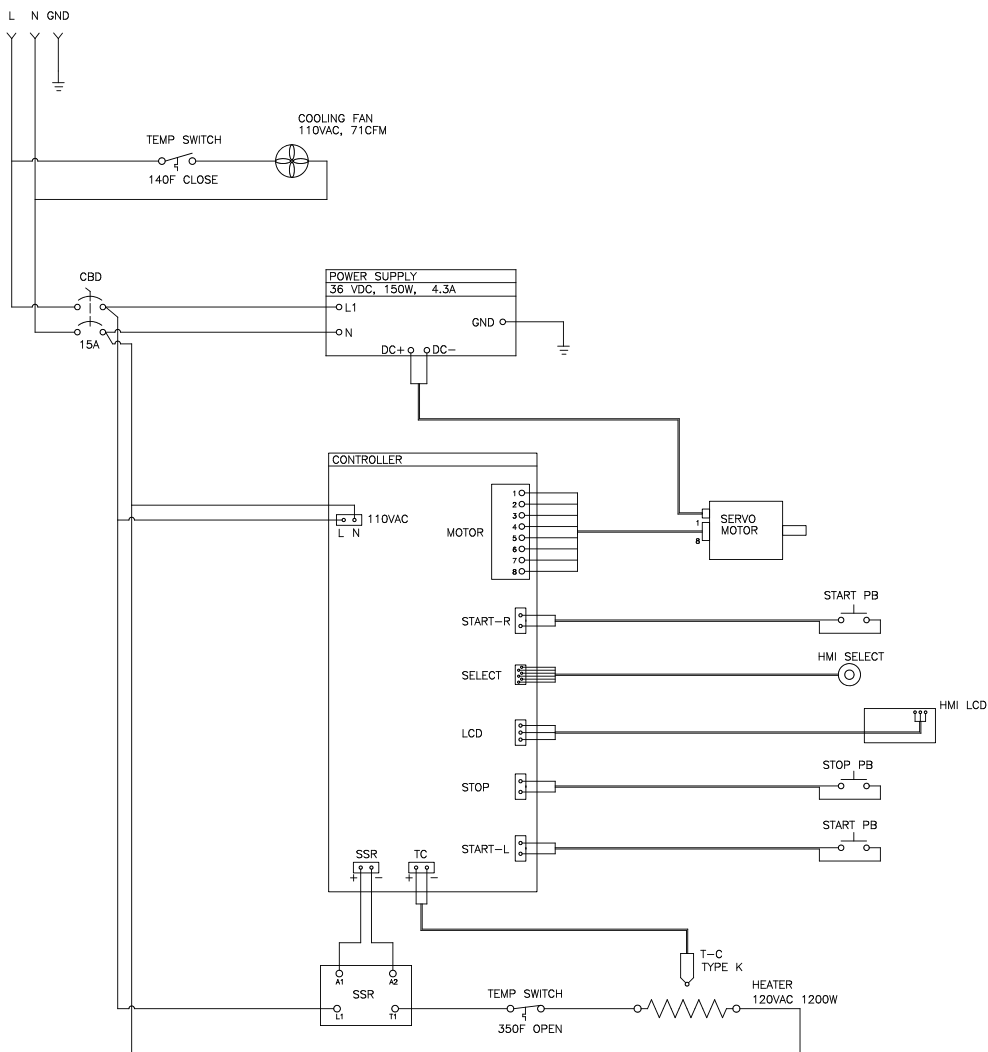

12. Options and Related Products

Paddles

Uni-Series Sealing Paddles



Uni-30/31/32 2-up
Item #1410



Uni-60/62 1-up
Item #1405

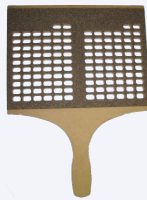

Uni-60/62 2-up
Item #1412

M-Series Sealing Paddles



M-30/31/32 1-up
Item #M400



M-30/31/32 2-up
Item #M410

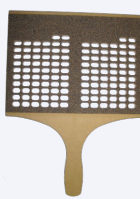

M-60/62 2-up
Item #M411

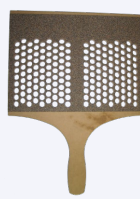

M-90 2-up
Item #M413

Specialty Paddles



UD-32 2-up
Item #UD410

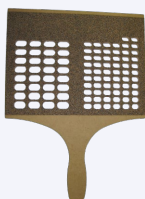

M-32/62 2-up
Item #M412



OP-Series 4-up
Item #OP410

12. Accessories and Related Products (continued)

Uni-Series Heat Sealing Accessories

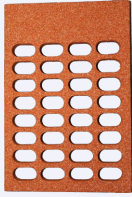

Uni 30/31/32
Item #1332

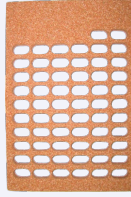

Uni 60/62
Item #1362

M-Series Heat Sealing Accessories

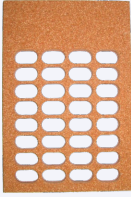

M-30/31/32
Item #M332

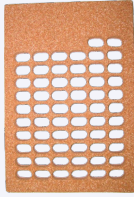

M-60/62
Item #M362

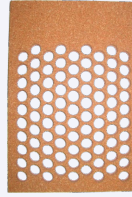

M-90
Item #M390



Control 30
Item #M335

Misc Accessories



AutoSealer Rails
Item #1002R



Pressure Board
Item #1047

13. Warranty

With the purchase of your **AutoSealer 1002** from Rx Systems, it includes a one year warranty that covers the unit from defects in materials and workmanship in relation to the specifications in the product manual.

For further information on your warranty please contact:

Tech Support Department

tsr@rxsystems.com

800-922-9142 phone

636-925-0041 fax

14. Maintenance and Repair History

Date	Condition	Work Performed	Part/s Replaced	By:



121 Point West Boulevard
St. Charles, MO 63301
1-800-922-9142
fax:1-636-925-0041
TSR@RxSystems.com
RxSystems.com